

Article number: 12347000060500  
Description: KLEE-coil 347 000 060.500  
M 6 St. steel 1.4305

## Measures

---

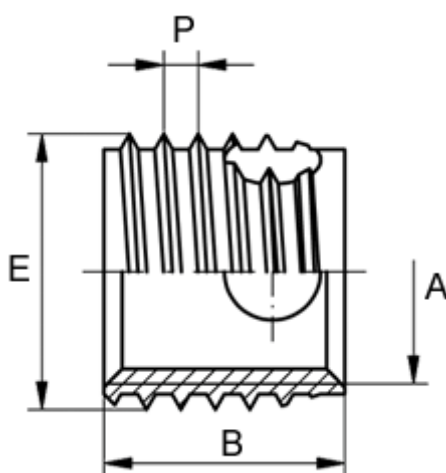

Female thread A	= M6
Length B	= 8
Male thread E	= 8.0
Min hole depth blind hole	= 10
Pre-drilled max	= 7.7
Pre-drilled min	= 7.5
Thread pitch P	= 1.00
Type	= 347 000 060 ...